

SERIE: BARANDILLA

ALUMINIOS Movil: 655 58 44 88

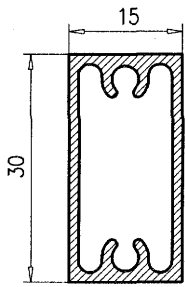

Tel: 96 299 40 50 Fax: 96 299 34 24



Rect. 30*15 aut.
472

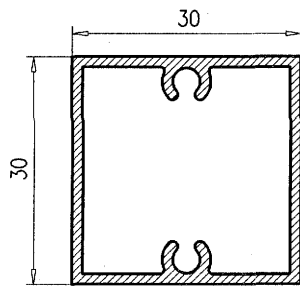

Cuadrado 30 aut.
100

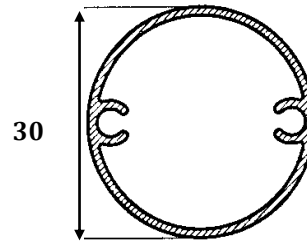

Redondo 30 aut.
831

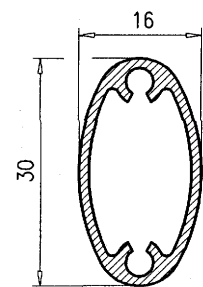

Ovalado aut.
830

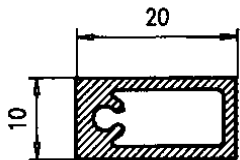

R 20*10 aut. **471**

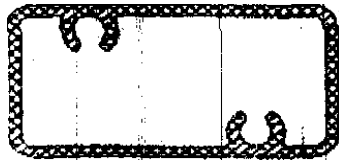

R 40*20 aut. **473**

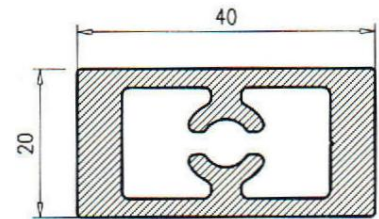

R. 40*20 aut. **7442**

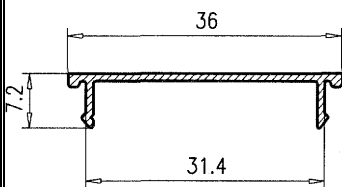

Grapa **800**

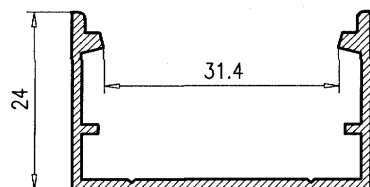

Forma U 25 **799**

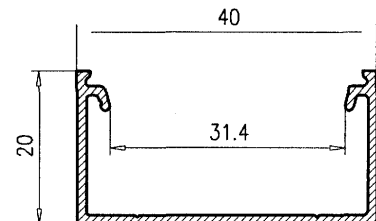

Forma U 20 **801**

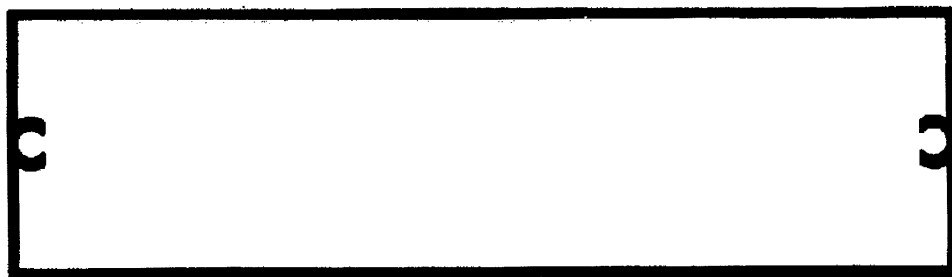

Rectángulo 150*40 autorroscado **R150*40**

SERIE: BARANDILLA

ALUMINIOS Movil: 655 58 44 88



Tel: 96 299 40 50 Fax: 96 299 34 24

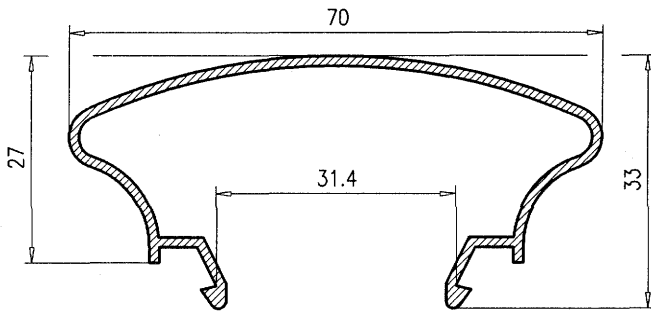

Pasamano Barandilla **321**

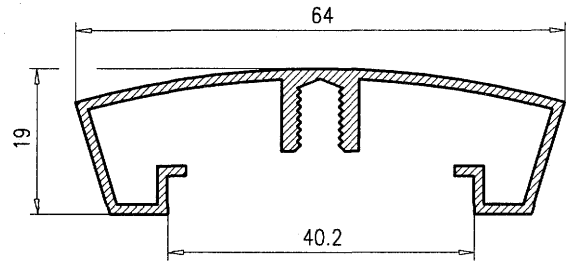

Pasamano autorroscado **127**

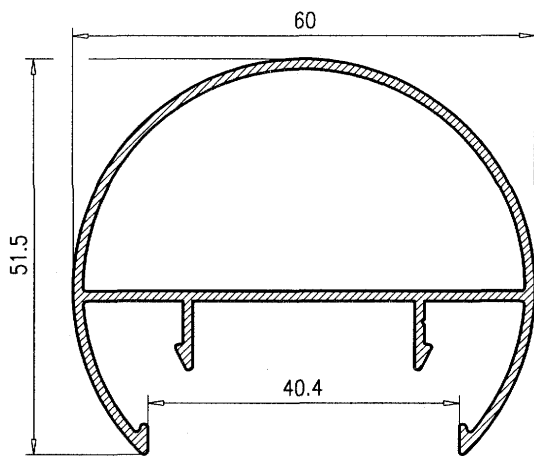

Pasamano Redondo 60 **322**

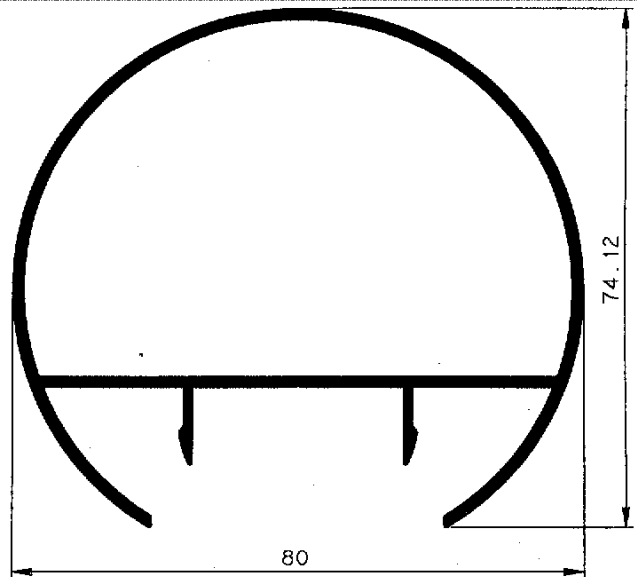

Pasamano Redondo 80 **323**

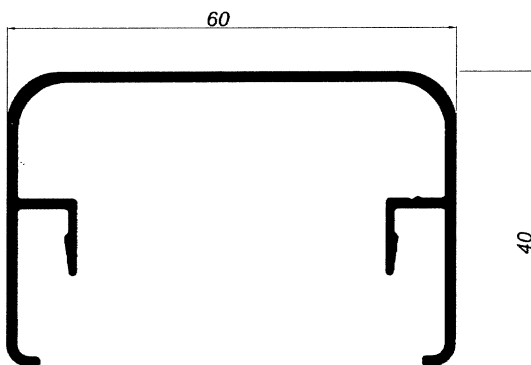

Pasamano Rectangular 60*40 **326**

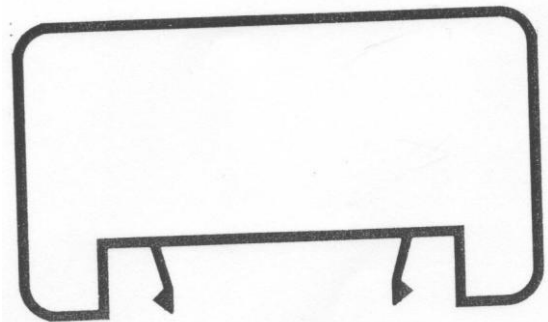

Pasamano Rectangular 70*40 **325**

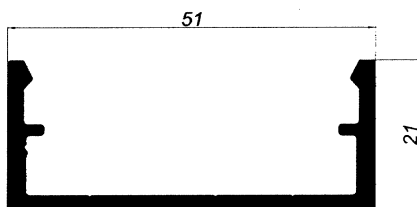

U
Pasamano
de 51
807

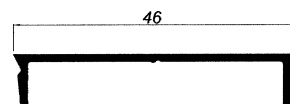

Tapa de 51
809

S.:BARANDILLA EUROPEA

ALUMINIOS Movil: 655 58 44 88
ALABADI
 Tel: 96 299 40 50 Fax: 96 299 34 24

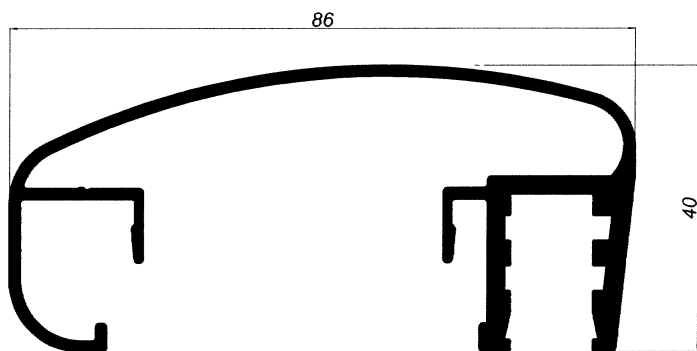

Pasamano 86 europeo acristalar **320**

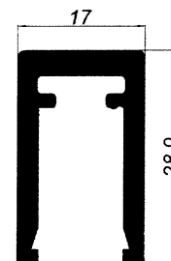

U para acristalar **810**

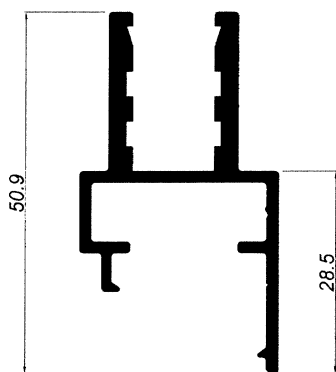

Anclaje Cristal **797**

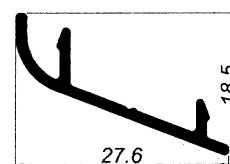
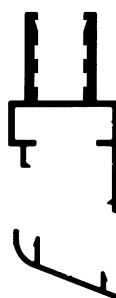

Tapa anclaje **796**

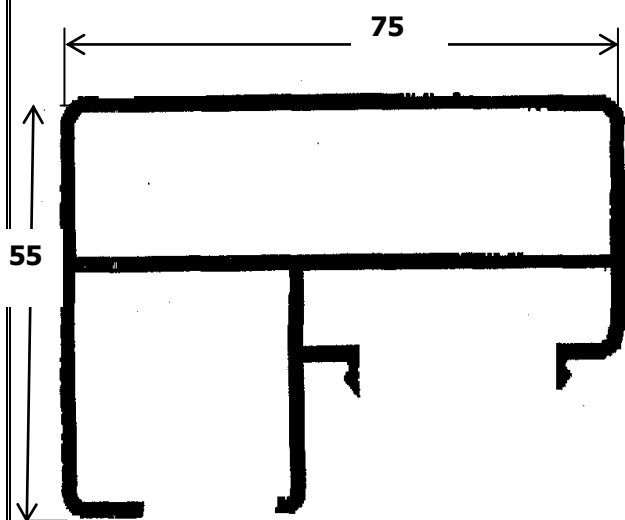

Pasamano Cristal **324**

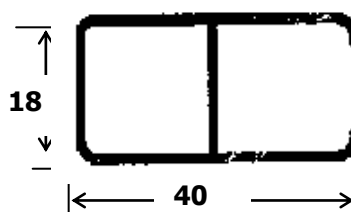

Hoja Cristal **038**

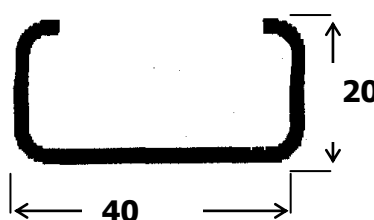

U Pasamano Cristal **798**