

# S.: GUIA PERSIANA y COMPACTOS

ALUMINIOS Movil: 655 58 44 88  
**ALABADI**<sup>S</sup><sub>L</sub>  
Tel: 96 299 40 50 Fax: 96 299 34 24

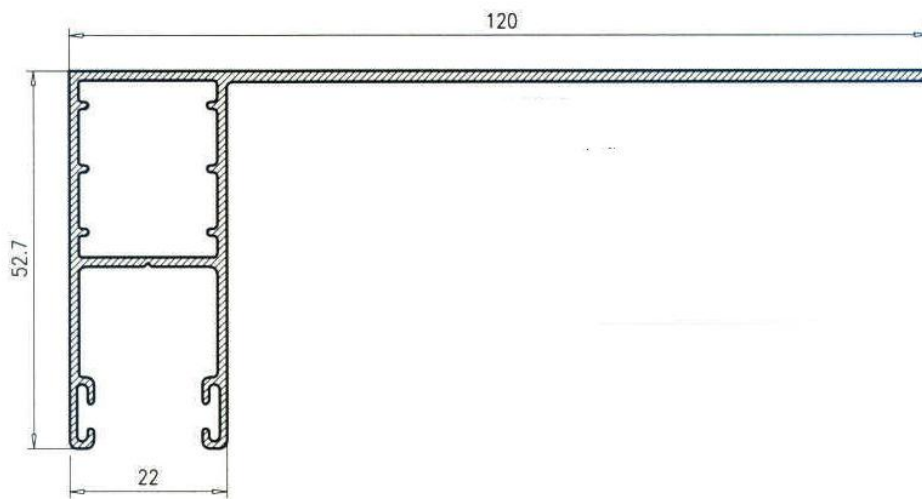

Guía 120  
Pala Lateral

**1993**

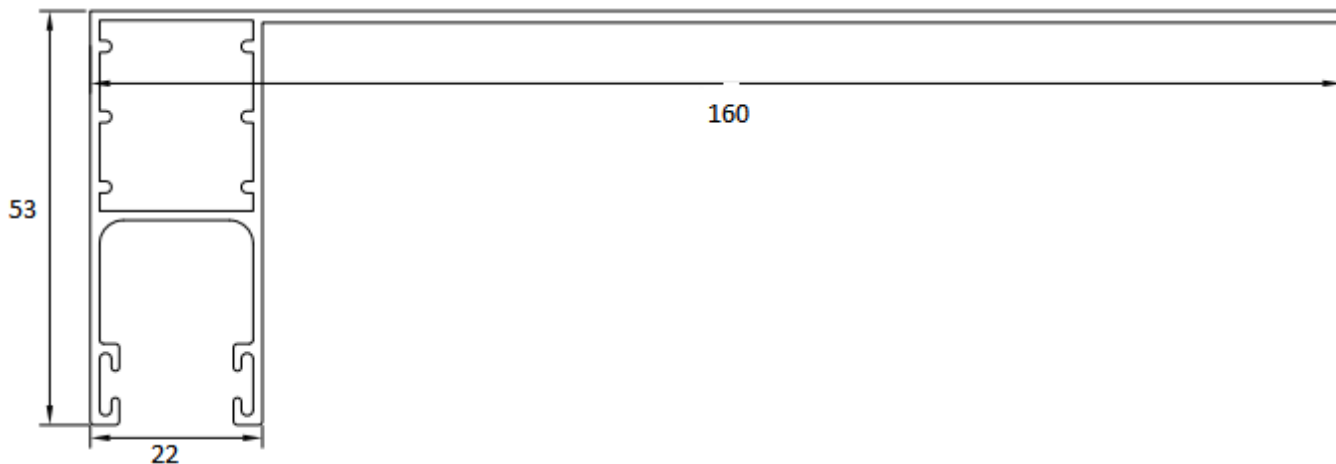

Guía 160 Pala Lateral **3259**

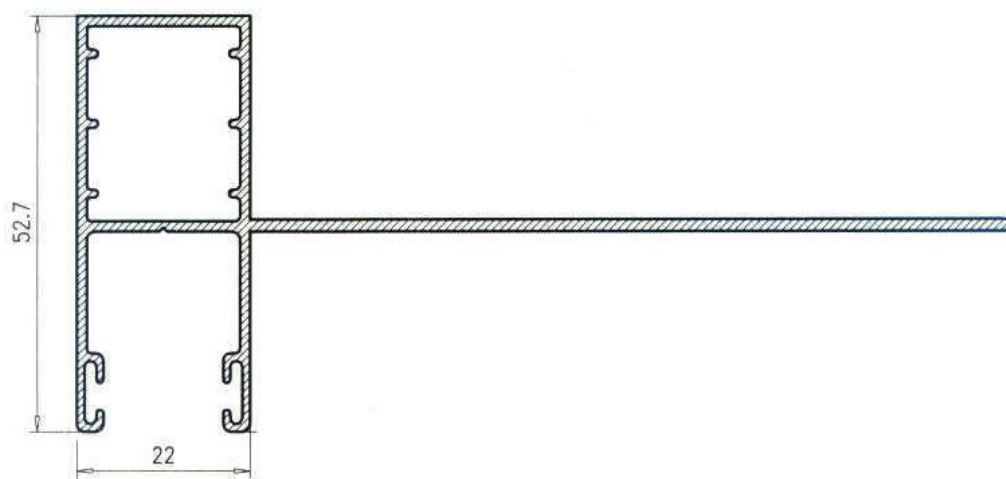

Guía pala  
central 120

**3190**

# S.: GUIA PERSIANA y COMPACTOS

ALUMINIOS Movil: 655 58 44 88



Tel: 96 299 40 50

Fax: 96 299 34 24

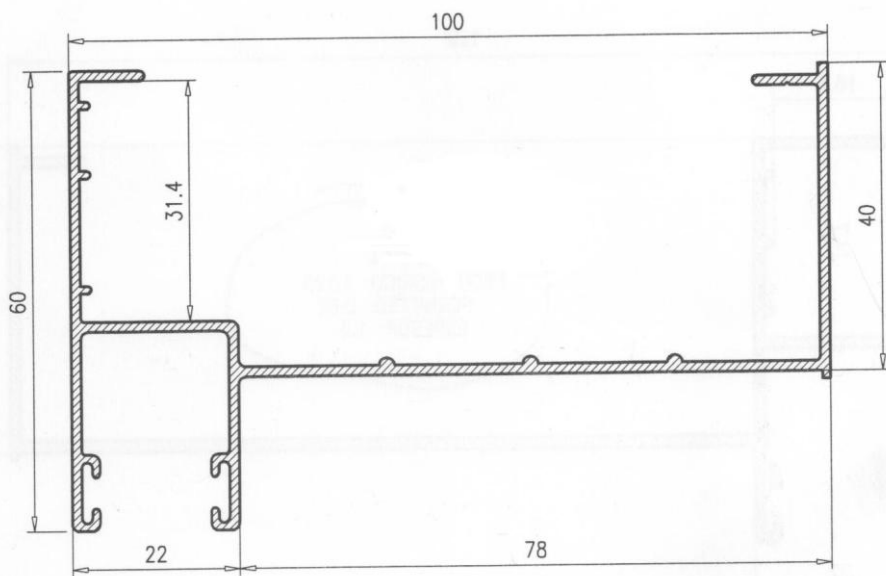

Guía 100 con solape.  
Guía Madrid  
**5476**

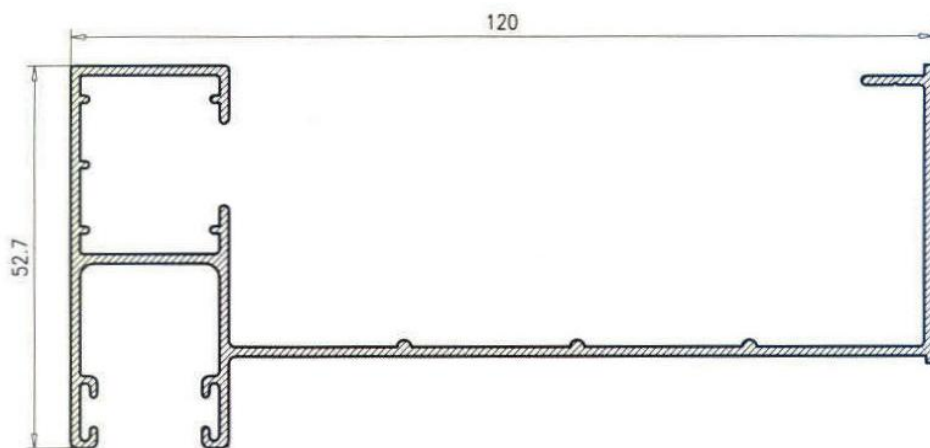

Guía 120 abierta  
con solape.  
Guía Madrid

**5470**



Guía 140  
Madrid  
**5477**

# S.: GUIA PERSIANA y COMPACTOS

ALUMINIOS Movil: 655 58 44 88



Tel: 96 299 40 50 Fax: 96 299 34 24

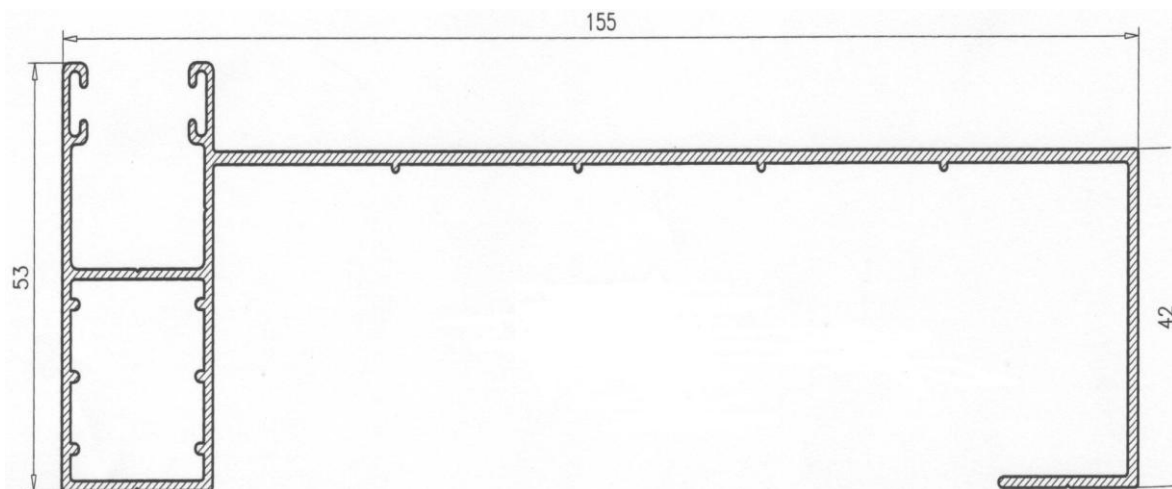

Guía 155 con solape Guía Madrid **5475**

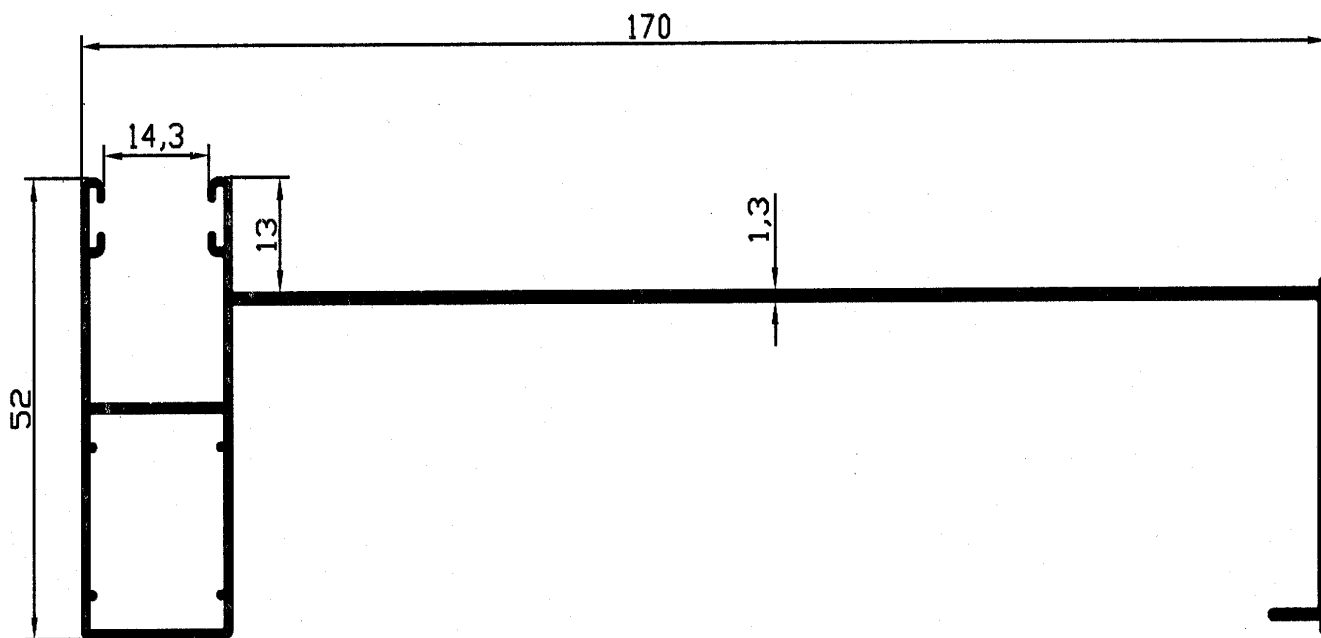

Guía 170 con solape Guia Madrid **8150**

# S.: GUIA PERSIANA

ALUMINIOS Movil: 655 58 44 88

**ALABADI**

Tel: 96 299 40 50

Fax: 96 299 34 24

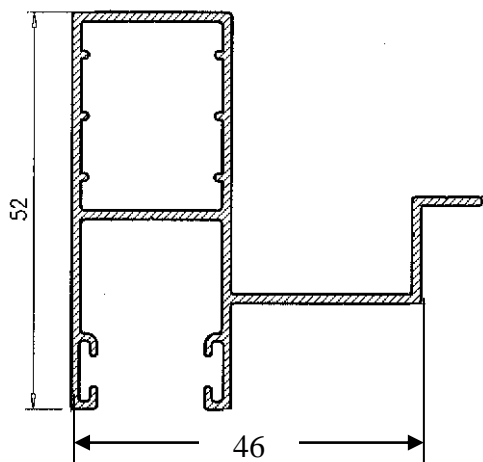

Guía Pala Int. 46 recogedor embutido.

**8143**

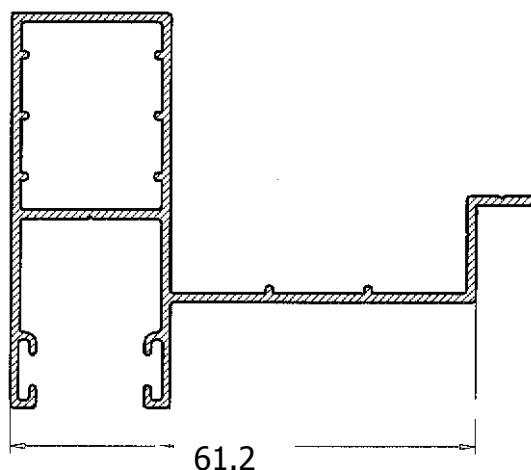

Guía Pala Interior 61.2 de recogedor embutido

**8145**

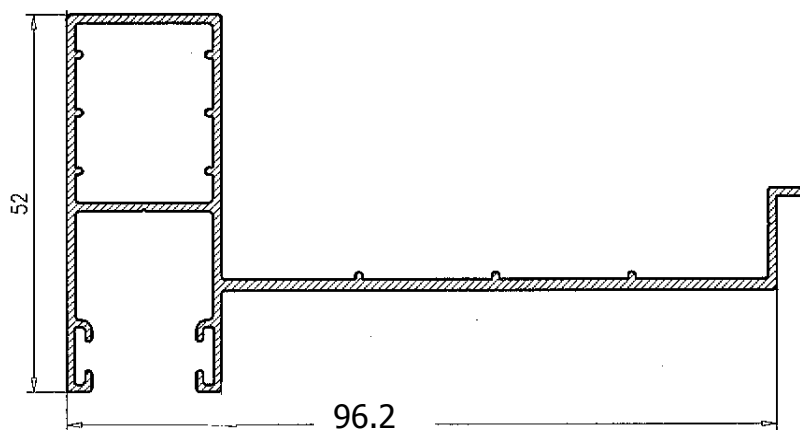

Guía Pala Interior 96.2 de recogedor embutido

**8149**

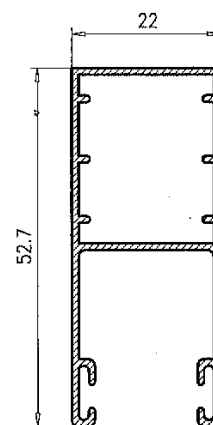

Guía Mini

**3522**

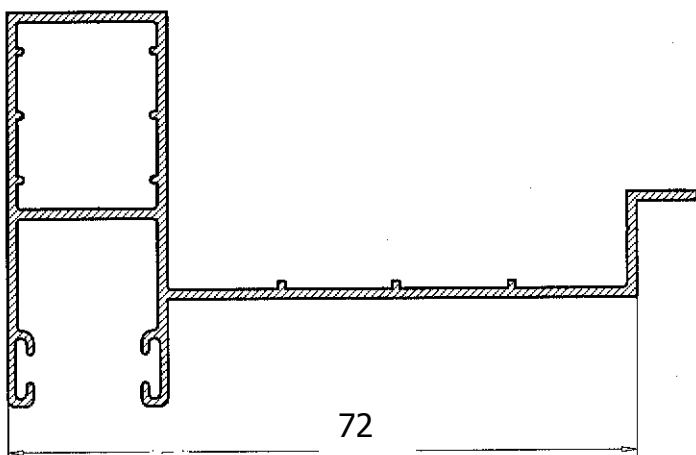

Guía Pala Interior 72 recogedor embutido

**8146**

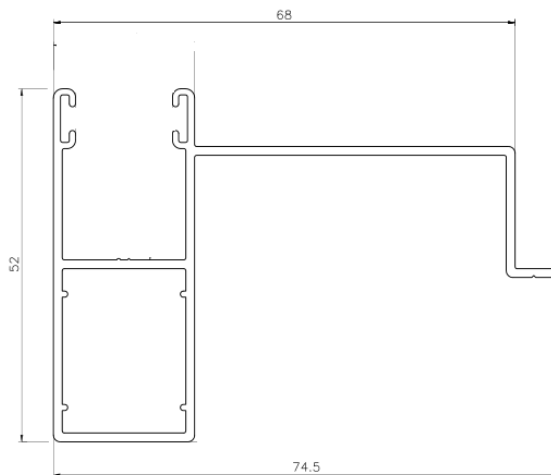

Guía para premarco RT 68

**5299**

# S.: GUIA PERSIANA

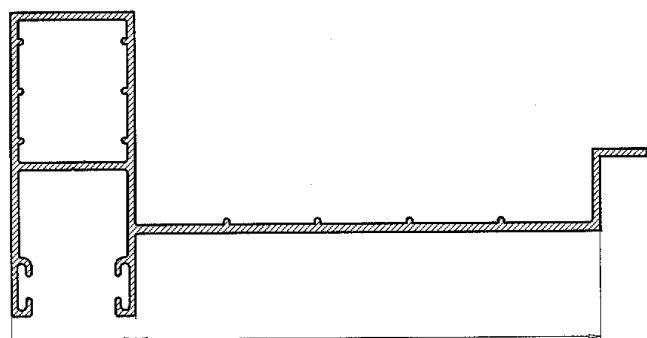

100.5

**4437** Guía Pala Interior 100.5  
de recogedor embutido

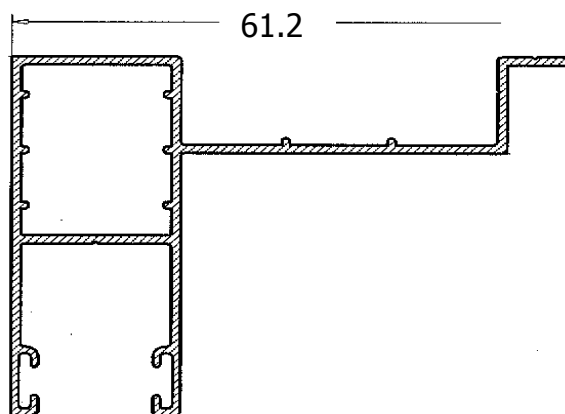

61.2

Guía Pala Exterior 61.2 de  
recogedor solapado **8144**

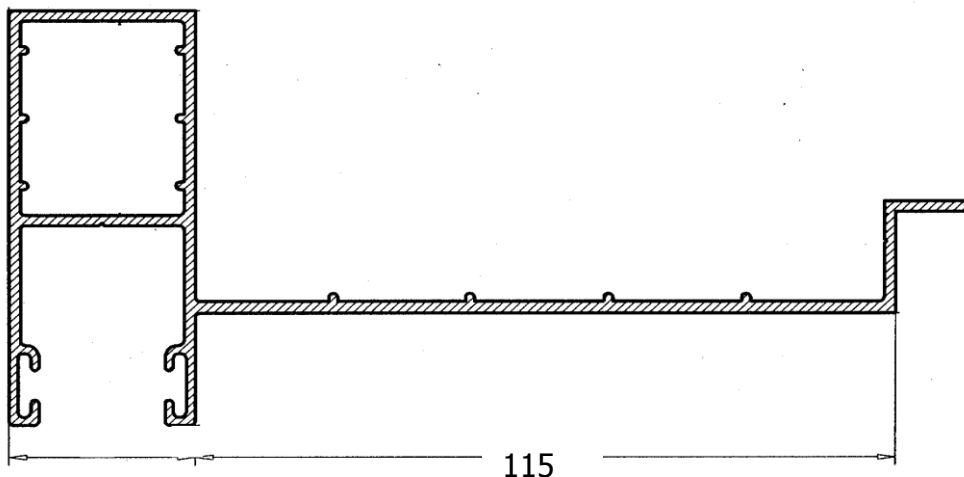

115

Guía Pala Interior 115  
de recogedor embutido  
**4438**

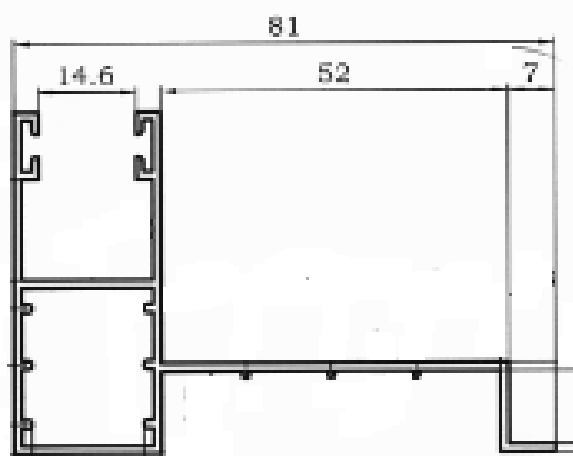

Guía Pala Exterior 74 recogedor  
solapado **8151**

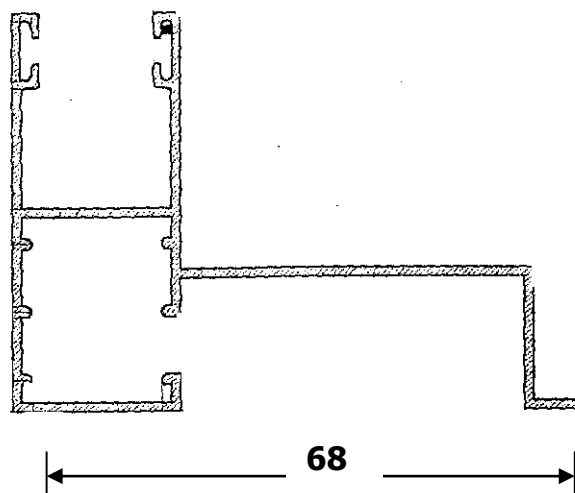

68

Guía Pala Exterior 68 de recogedor  
solapado **8142**

# S.: GUIA PERSIANA y COMPACTOS

ALUMINIOS Movil: 655 58 44 88



Tel: 96 299 40 50 Fax: 96 299 34 24

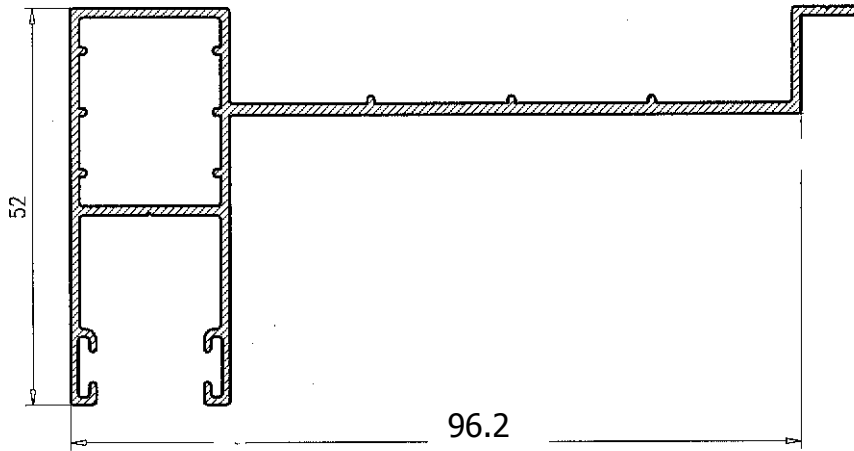

Guía Pala  
Exterior 96.2  
de recogedor  
solapado

**8148**

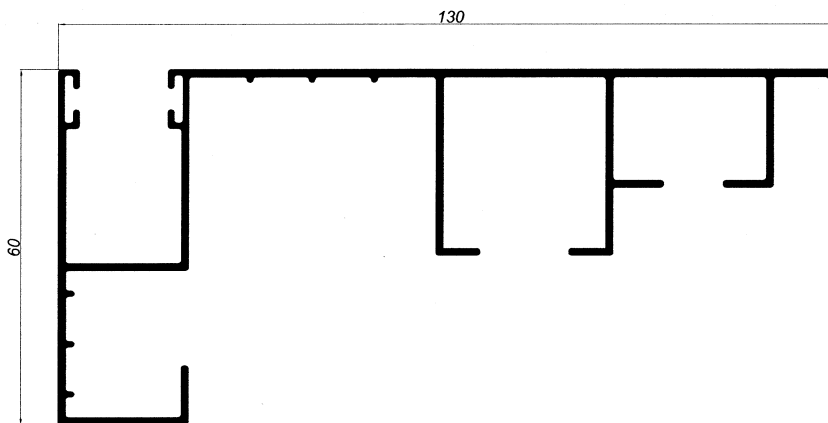

Guía Recogedor  
de 130 con  
premarco de obra

**8185**

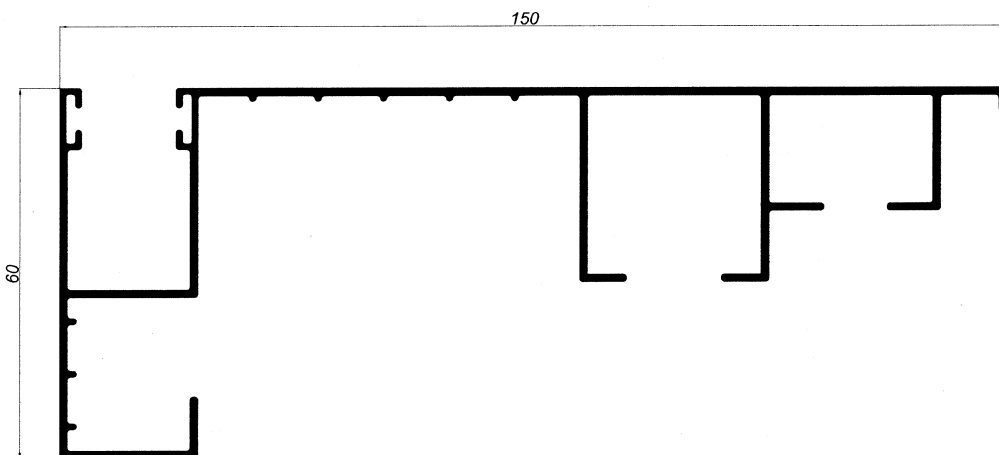

Guía Recogedor  
de 150 con  
premarco de obra

**8260**

# S.: GUIA PERSIANA y COMPACTOS

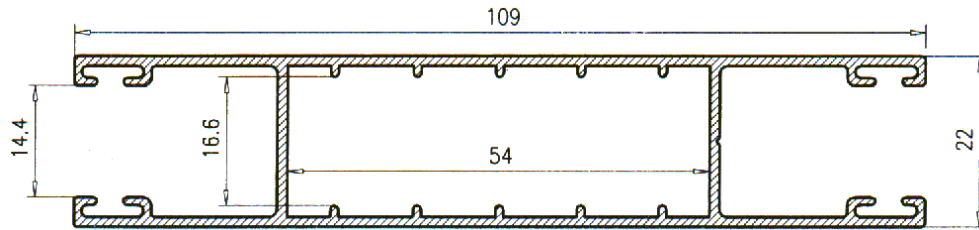

Guía Doble Persiana **3521**

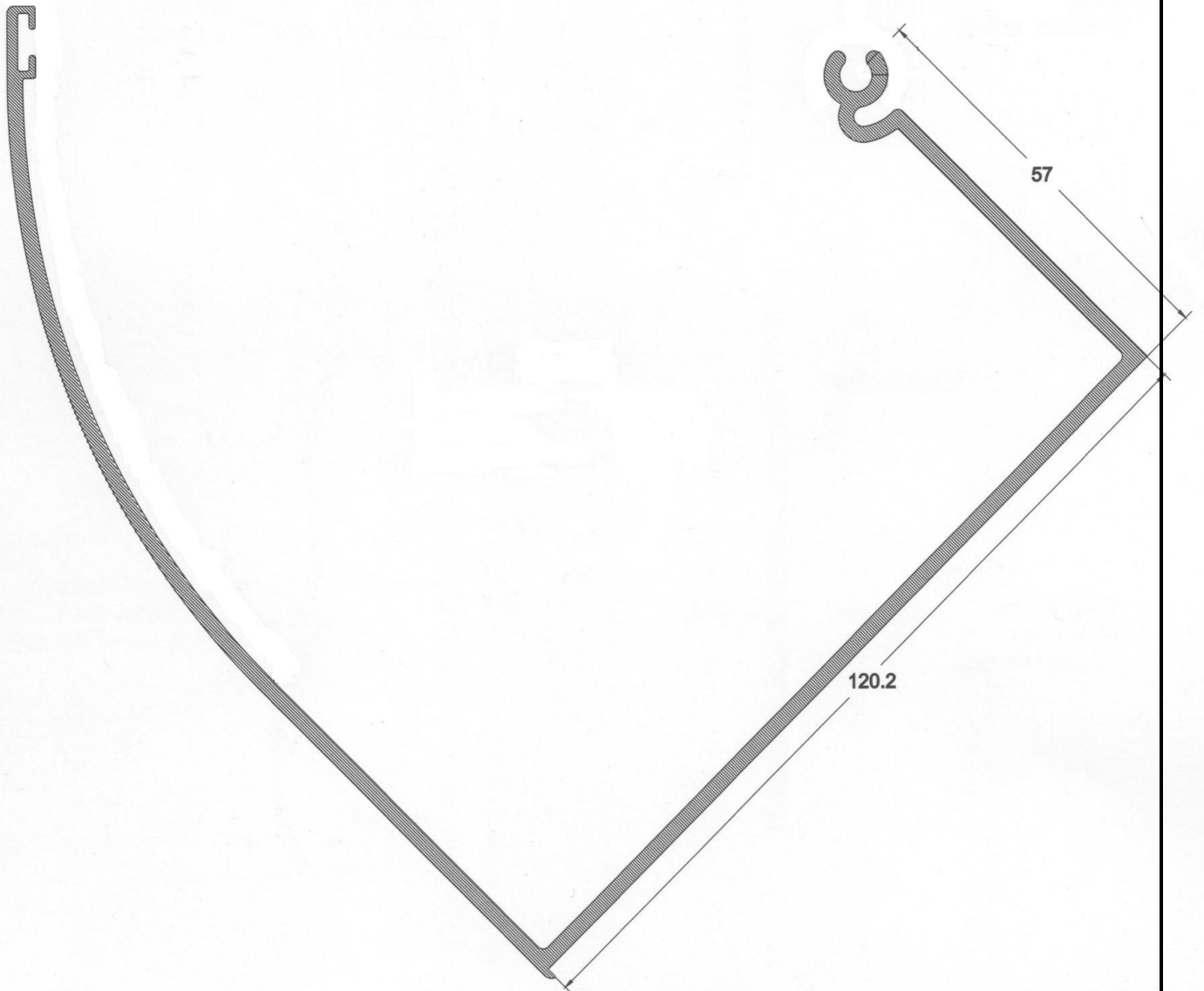

Esquinero Regulable Macho **11011**

# S.: GUIA PERSIANA y COMPACTOS

ALUMINIOS Movil: 655 58 44 88  
**ALABADÍ**  
Tel: 96 299 40 50 Fax: 96 299 34 24

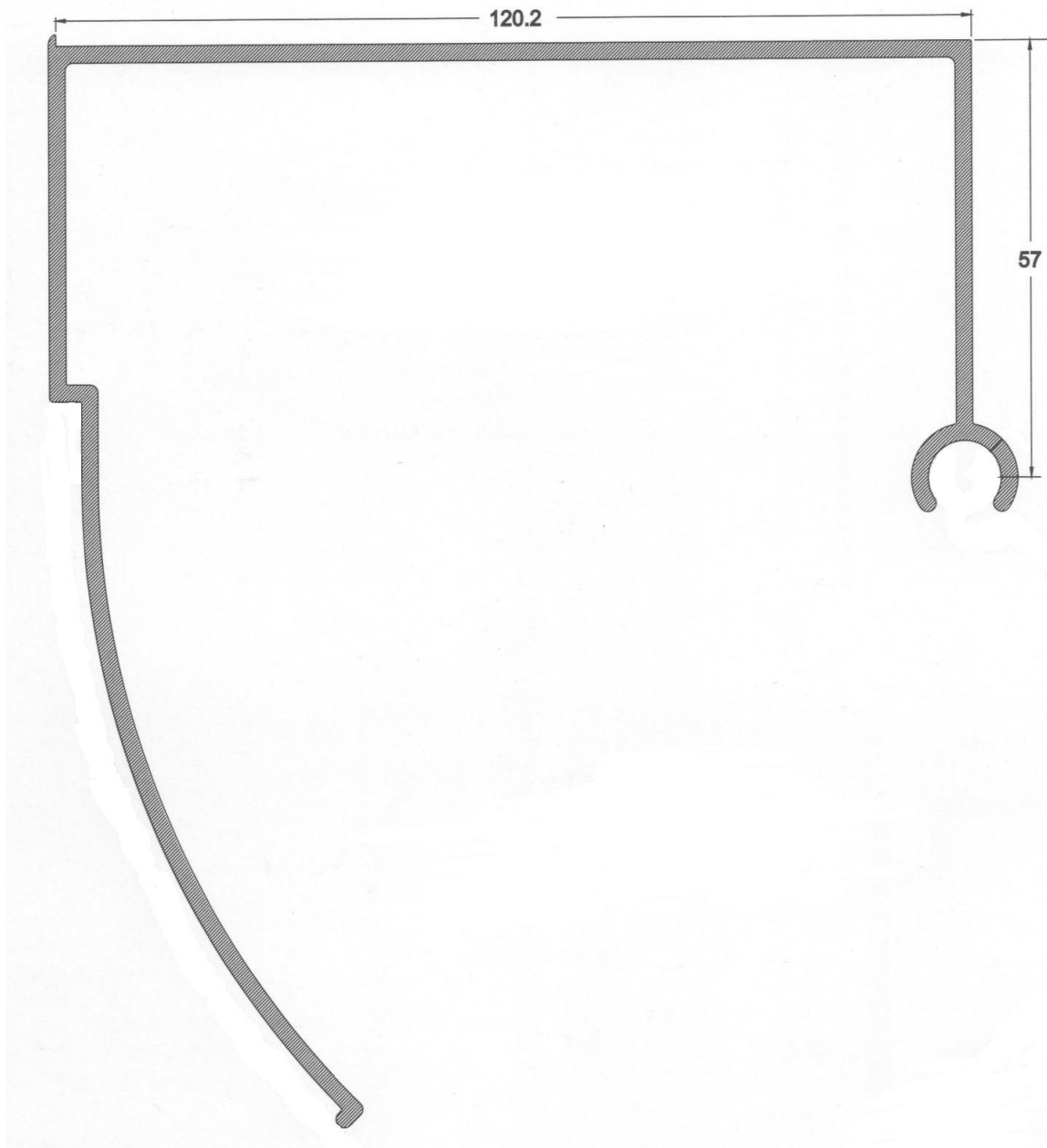

Esquinero Regulable Hembra **11012**

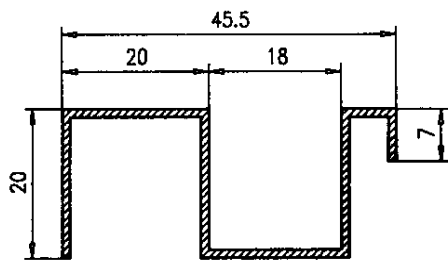

Guía 46 **G46**

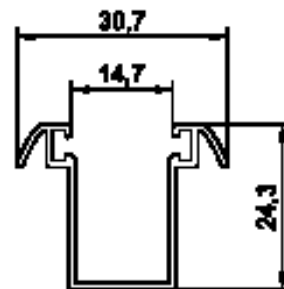

Guía Embutir V-25 **920**



# S.: GUIA PERSIANA y COMPACTOS

ALUMINIOS Movil: 655 58 44 88



Tel: 96 299 40 50 Fax: 96 299 34 24

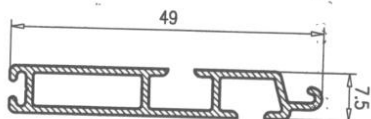

Terminal Persiana 40  
**4384**

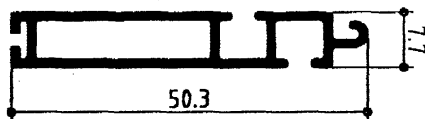

Terminal Persiana 50  
**4385**

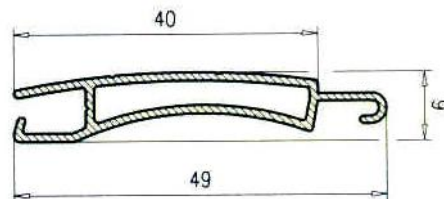

Lama Persiana 40 **7932**

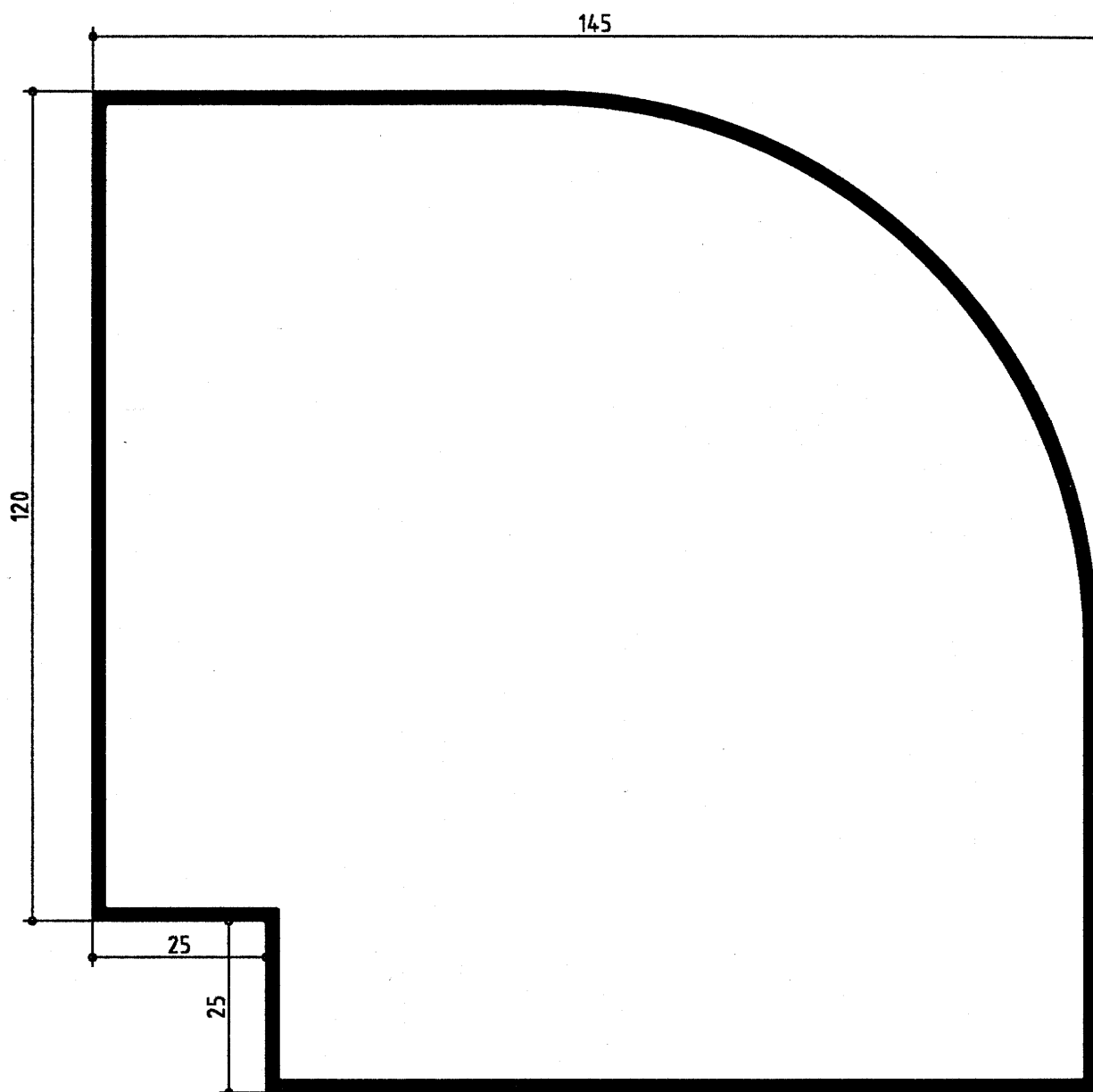

Esquinero Compacto 145

**11013**